

Owner's Guide

SONY

Q U A L I A 017

Owner's Record

The model and serial numbers are located at the rear of the disc compartment lid. Record the serial number in the space provided below. Refer to them whenever you call upon your Sony dealer regarding this product.

Model No. Q017-MD1

Serial No. _____

WARNING

To prevent fire or shock hazard, do not expose the unit to rain or moisture.

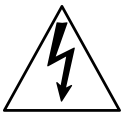
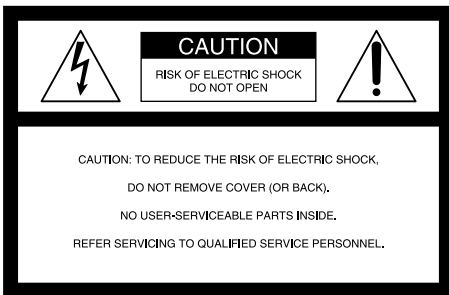

This symbol is intended to alert the user to the presence of uninsulated “dangerous voltage” within the product’s enclosure that may be of sufficient magnitude to constitute a risk of electric shock to persons.



This symbol is intended to alert the user to the presence of important operating and maintenance (servicing) instructions in the literature accompanying the appliance.

Do not install the appliance in a confined space, such as a bookcase or built-in cabinet.

To prevent fire, do not cover the ventilation of the apparatus with newspapers, table-cloths, curtains, etc. And don't place lighted candles on the apparatus.

To prevent fire or shock hazard, do not place objects filled with liquids, such as vases, on the apparatus.

Certain countries may regulate disposal of the battery used to power this product. Please consult with your local authority.

Caution

The use of optical instruments with this product will increase eye hazard.

CAUTION-INVISIBLE LASER
RADIATION WHEN OPEN

DO NOT STARE INTO BEAM OR VIEW
DIRECTLY WITH OPTICAL INSTRUMENTS

Information

IN NO EVENT SHALL SELLER BE LIABLE FOR ANY DIRECT, INCIDENTAL OR CONSEQUENTIAL DAMAGES OF ANY NATURE, OR LOSSES OR EXPENSES RESULTING FROM ANY DEFECTIVE PRODUCT OR THE USE OF ANY PRODUCT.

Product registration

Please register this product on line at www.sony.com/productregistration
<<http://www.sony.com/productregistration>>

Proper registration will enable us to send you periodic mailings about new products, services and other important announcements. Registering your product will also allow us to contact you in the unlikely event that the product needs adjustment or modification.
Thank you.

THIS DEVICE COMPLIES WITH PART 15 OF THE FCC RULES. OPERATION IS SUBJECT TO THE FOLLOWING TWO CONDITIONS:

- (1) THIS DEVICE MAY NOT CAUSE HARMFUL INTERFERENCE, AND
- (2) THIS DEVICE MUST ACCEPT ANY INTERFERENCE RECEIVED, INCLUDING INTERFERENCE THAT MAY CAUSE UNDESIRE OPERATION.

Information

This equipment has been tested and found to comply with the limits for a Class B digital device, pursuant to Part 15 of the FCC Rules.

These limits are designed to provide reasonable protection against harmful interference in a residential installation. This equipment generates, uses, and can radiate radio frequency energy and, if not installed and used in accordance with the instructions, may cause harmful interference to radio communications.

However, there is no guarantee that interference will not occur in a particular installation. If this equipment does cause harmful interference to radio or television reception, which can be determined by turning the equipment off and on, the user is encouraged to try to correct the interference by one or more of the following measures:

- Reorient or relocate the receiving antenna.
- Increase the separation between the equipment and receiver.
- Connect the equipment into an outlet on a circuit different from that to which the receiver is connected.
- Consult the dealer or an experienced radio/TV technician for help.

You are cautioned that any changes or modifications not expressly approved in this manual could void your authority to operate this equipment.

RECYCLING LITHIUM-ION BATTERIES

Lithium-Ion batteries are recyclable.



You can help preserve our environment by returning your used rechargeable batteries to the collection and recycling location nearest you.

For more information regarding recycling of rechargeable batteries, call toll free 1-800-822-8837, or visit <http://www.rbrc.org/>

Caution: Do not handle damaged or leaking lithium-ion batteries.

On this manual

These operating instructions are written mainly for models outside of Japan. In the case of the model for use in Japan, the display indications may differ slightly, but operations are identical.

IMPORTANT SAFEGUARDS

For your protection, please read these safety instructions completely before operating the appliance, and keep this manual for future reference.

Carefully observe all warnings, precautions and instructions on the appliance and in the operating instructions, and adhere to them.

INSTALLATION

Water and Moisture — Do not use powerline operated appliances near water—for example, near a bathtub, washbowl, kitchen sink, or laundry tub, in a wet basement, or near a swimming pool, etc.

Heat — Do not place the appliance near or over a radiator or heat register, or where it is exposed to direct sunlight.

Ventilation — The slots and openings in the cabinet are provided for necessary ventilation. To ensure reliable operation of the appliance, and to protect it from overheating, these slots and openings must never be blocked or covered.

- Never cover the slots and openings with a cloth or other materials.
- Never block the slots and openings by placing the appliance on a bed, sofa, rug, or other similar surface.
- Never place the appliance in a confined space, such as a bookcase or built-in cabinet, unless proper ventilation is provided.

Accessories — Do not place the appliance on an unstable cart, stand, tripod, bracket, or table. The appliance may fall, causing serious injury to a child or an adult, and serious damage to the appliance. Use only a cart, stand, tripod, bracket, or table recommended by Sony.

USE

Power Source — This appliance should be operated only from the type of power source indicated on the marking label. If you are not sure of the type of electrical power supplied to your home, consult your dealer or local power company. For those appliances designed to operate from battery power, or other sources, refer to the operating instructions.

Grounding or Polarization — This appliance is equipped with a polarized AC power cord plug (a plug having one blade wider than the other), or with a three-wire grounding type plug (a plug having a third pin for grounding). Follow the instructions below:

- **For the appliance with a polarized AC power cord plug:**

This plug will fit into the power outlet only one way. This is a safety feature. If you are unable to insert the plug fully into the outlet, try reversing the plug. If the plug should still fail to fit, contact your electrician to have a suitable outlet installed. Do not defeat the safety purpose of the polarized plug by forcing it in.
- **For the appliance with a three-wire grounding type AC plug:**

This plug will only fit into a grounding-type power outlet. This is a safety feature. If you are unable to insert the plug into the outlet, contact your electrician to have a suitable outlet installed. Do not defeat the safety purpose of the grounding plug.

Overloading — Do not overload wall outlets, extension cords, or convenience receptacles beyond their capacity, since this can result in fire or electric shock.

When not in use — Unplug the power cord of the appliance from the outlet when left unused for a long period of time. To disconnect the cord, pull it out by grasping the plug. Never pull the plug out by the cord.

Power-Cord Protection — Route the power cord so that it is not likely to be walked on or pinched by items placed upon or against them, paying particular attention to the plugs, receptacles, and the point where the cord exits from the appliance.

Lightning — For added protection for this appliance during a lightning storm, or when it is left unattended and unused for long periods of time, unplug it from the wall outlet and disconnect the antenna or cable system. This will prevent damage to the appliance due to lightning and powerline surges.

Attachments — Do not use attachments not recommended by Sony, as they may cause hazards.

Cleaning — Unplug the appliance from the wall outlet before cleaning or polishing it. Do not use liquid cleaners or aerosol cleaners. Use a cloth lightly dampened with water for cleaning the exterior of the appliance. Clean the appliance only as recommended by Sony.

Object and Liquid Entry — Never push objects of any kind into the appliance through openings as they may touch dangerous voltage points or short out parts that could result in a fire or electric shock. Never spill liquid of any kind on the appliance.

SERVICE

Damage Requiring Service — Unplug the appliance from the wall outlet and refer servicing to qualified service personnel under the following conditions:

- When the power cord or plug is damaged or frayed.
- If liquid has been spilled or objects have fallen into the appliance.
- If the appliance has been exposed to rain or water.
- The appliance does not appear to operate normally or exhibits a marked change in performance. — This indicates a need for service.
- If the appliance does not operate normally when following the operating instructions, adjust only those controls that are specified in the operating instructions. Improper adjustment of other controls may result in damage and will often require extensive work by a qualified technician to restore the appliance to normal operation.
- If the appliance has been subject to excessive shock by being dropped, or the cabinet has been damaged.

Servicing — Do not attempt to service the appliance yourself as opening or removing covers may expose you to dangerous voltage or other hazards. Refer all servicing to qualified service personnel.

Replacement Parts — When replacement parts are required, be sure the service technician has used replacement parts specified by Sony that have the same characteristics as the original parts. Unauthorized substitutions may result in fire, electric shock, or other hazards.

Safety Check — Upon completion of any service or repairs to the appliance, ask the service technician to perform routine safety checks (as specified by Sony) to determine that the appliance is in safe operating condition.

Q U A L I A 017

Overview

Identifying parts and controls	10
--------------------------------------	----

Getting Started

Charging the battery	14
Checking the battery's remaining power	16
Adjusting the headphones to fit your ears	17

Playback

Playing an MD	18
Locking the controls – HOLD	20
Changing the playback operations	21
Changing the play mode – P-MODE/↻	22
Selecting the sound mode – V-SUR/SOUND	26

Settings

Changing the settings.....	28
Menu option.....	29
“Useful” menu (Disc Memory/SpeedControl).....	29
“Option” menu (AVLS/Beep/Backlight/表示方式選擇/Power Mode).....	30

Additional Information

Caring for the player.....	32
Precautions.....	33
Troubleshooting.....	38
Specifications.....	41
Index.....	42

Identifying parts and controls

Player

5-way control key



Plays the MD and adjusts the volume.

GROUP button

Selects a group in an MD to play.

Operation lamp

Displays the remaining power of the battery, the play mode, etc.

🎧 (headphones) jack



Player (when lid is open)

HOLD switch

Prevents accidental button presses.

OPEN lever

Opens the lid of the player.

Terminals for the battery charging stand

BUILT-IN BATTERY switch

Switches the power supply to the player on or off. Normally keep the switch to the ON position.



Remote Control (Remote)

HOLD button
Prevents accidental button presses.

DISPLAY button
Changes the information on the remote display.

P-MODE/⏮ (repeat) button
Changes the play mode.

SOUND button
Changes the sound mode.



Headphones



Remote display
Displays the remaining power of the battery, the play mode, and playing status.

to the player

VOLUME control
Adjusts the volume.

■ (stop) button
Stops playback of an MD.

⏮ (Group) +/- buttons
Selects a group in an MD to play.

Jog lever (⏮/ENT/▶▶)
Plays an MD and selects tracks, items, and settings.

Continued on the next page →

Identifying parts and controls (continued)

Remote display

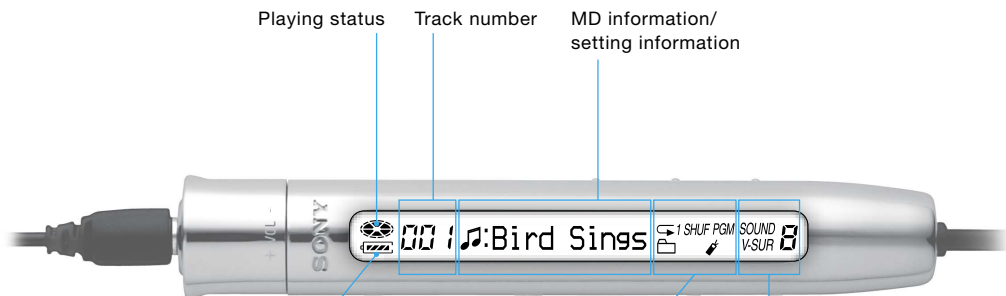

Remaining battery power

Play mode
Shows the current play mode.

Sound mode
Shows the current mode.

Display	Play/mode
	Playing tracks repeatedly.
1 SHUF PGM 	Playing tracks in the option you choose.
	Playing tracks by group as set in the MD.

Display	Play/mode
SOUND H	Heavy
SOUND P	Pops
SOUND J	Jazz
SOUND U	Unique
SOUND 1	Custom1
SOUND 2	Custom2
V-SUR S	Studio
V-SUR L	Live
V-SUR C	Club
V-SUR A	Arena

Supplied accessories

- Remote

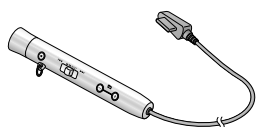

- Headphones
(with medium-sized earbuds attached)



- Earbuds
(large size/small size)
Use the earbuds that fit the size of your ears.

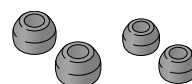

- Neckchain to the remote



- Battery charging stand

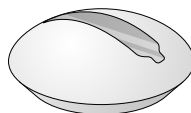

- Carrying case



- Cleaning cloth
(the white cloth that the player was wrapped in when you purchased it)

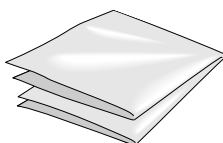

- Headphone adaptor

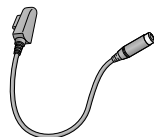

- AC power adaptor

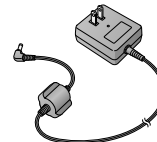

- "Owner's Guide" (this book)
(supplied with a document case)

Notes

- To prevent short-circuit, do not place any metal items, such as coins, keys, necklaces, etc., on the battery charging stand.
- To prevent short-circuit, do not carry or keep the player together with any metal items, such as coins, keys, necklaces, etc.
- Attach the neckchain to the remote as shown below.

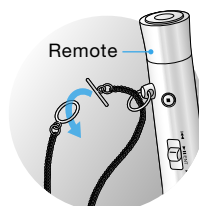

Charging the battery



To connect the AC power adaptor to the battery charging stand

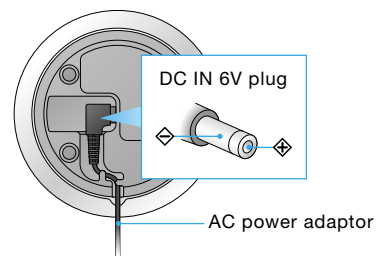

Insert the DC IN 6V plug on the AC power adaptor securely into the jack on the bottom of the battery charging stand. Then pass the cord along the groove at the bottom of the battery charging stand.

Battery charging stand (bottom view)



The built-in rechargeable battery is charged using the battery charging stand. Charge the battery at a temperature of 0°C (+32°F) to +40°C (+104°F).

To operate the player on power from a wall outlet, place the player on the battery charging stand. In this case, the built-in rechargeable battery will not be charged.

- 1 As shown on page 14, insert the DC IN 6V plug on the AC power adaptor securely into the jack on the bottom of the battery charging stand. Then insert the power plug on the AC power adaptor into a wall outlet.
Use only the supplied AC power adaptor (see the illustration on page 14 for the polarity of the plug). If you use any other AC power adaptor, the player may malfunction.
- 2 Connect the headphone plug on the remote to the  (headphones) jack on the player. Then connect the stereo mini plug of the headphones to the stereo minijack on the remote.
- 3 If the BUILT-IN BATTERY switch is set to OFF, slide the switch to ON (page 32).
- 4 Place the player on the battery charging stand to start charging.
The operation lamp on the player lights up, and  (disc) on the remote display starts moving. For details on the charging status, refer to the table on the right.

To check the charging status

Check the charging status with the operation lamp on the player or the remote display, and refer to the table below.

The display that shows the charging status disappears when the battery is about 80% charged. This amount is sufficient for normal playback. If you continue charging about 2.5 hours more after the display disappears, the battery will be fully charged, and you can operate the player for a longer time before the battery needs to be charged again.

Charging progress chart (approx. %)

Operation lamp	Remote display*	Charging progress (approx.)	Charging time (approx.)
Red	CHG:65min	0%	0 hour
↓	↓	↓	↓
Orange	CHG:25min	50%	↓
↓	↓	↓	↓
Green	CHG:09min	70%	↓
↓	↓	↓	↓
Light turns off	Light turns off	80%	1 hour
↓	↓	↓	↓
After light turns off	After light turns off	Fully charged	3.5 hours

* The amount of time required to charge the battery up to about 80% is displayed.

Notes

- The charging time varies depending on the room temperature.
- It may take up to one minute until you can check the charging status with the operation lamp on the player or the  (battery) on the remote display, depending on the condition of the rechargeable battery.

Continued on the next page >>>

Charging the battery (continued)

Checking the battery's remaining power

The battery life of the built-in rechargeable battery varies depending on the recording mode of the MD. For details on battery life, refer to the following table.

Approximate playing time of the lithium-ion built-in rechargeable battery* (JEITA**) (when the battery is fully charged)







SP mode	LP2 mode	LP4 mode
21 hours	27 hours	33 hours

* Approximate time when "Power Mode" is set to "Power Save" (page 31).

** Measured in accordance with the JEITA (Japan Electronics and Information Technology Industries Association) standard (using a Sony MDW-series Mini-disc).



Check the operation lamp on the player or  (battery) on the remote display to see how much battery power is left. Recharge the battery when the level of remaining power is low.

Display of the remaining power*

Operation lamp	Remote display	Remaining power
Lights up		There is sufficient battery power.
Lights up	 	The number of black sections decreases as the power is used.
Flashes slowly		Lights up The power is low.
Flashes quickly		Flashes The power is almost gone.
Turns off		Flashes There is no power left. "LOW BATT" flashes in the display, and the power turns off.

* Press the DISPLAY button on the remote when "Power Mode" is set to "Power Save" (page 31).  (battery) is displayed for several seconds.

Notes

-  (battery) may not be displayed correctly while you are fast-forwarding or fast-reversing.
- The battery life may vary even under the same recording mode or the same  (battery) display, depending on the charging time, the operating conditions, or the room temperature.

Adjusting the headphones to fit your ears

To replace the earbuds

Use the supplied headphones with the earbuds attached.

If the earbuds do not fit in your ears well, you may not be able to hear bass sounds properly. To enjoy better sound quality, insert the headphones into your ears so that the earbuds fit snugly.

If the earbuds do not fit your ears, replace them with the large or small ones (supplied). At the time of purchase, the medium-sized earbuds are already attached to the headphones.

How to attach the earbuds

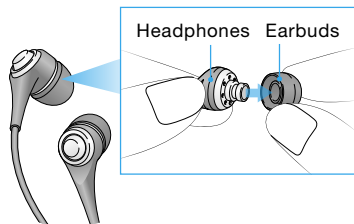

To use the headphone adaptor

You can connect the headphones to the player directly without using the remote.

Connect the headphones and the headphone adaptor as shown below.

When you use commercially available stereo headphones, be aware of the following:

- Headphones with a stereo mini plug can be connected; however, headphones with a micro plug cannot be used.
- Some of the noise-canceling headphones that reduce the surrounding noise may not be able to be connected. (For Sony models: MDR-NC20, MDR-NC11, and MDR-NC5)

How to attach the headphone adaptor

Headphone adaptor Stereo mini plug

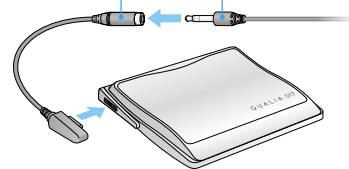

Playing an MD

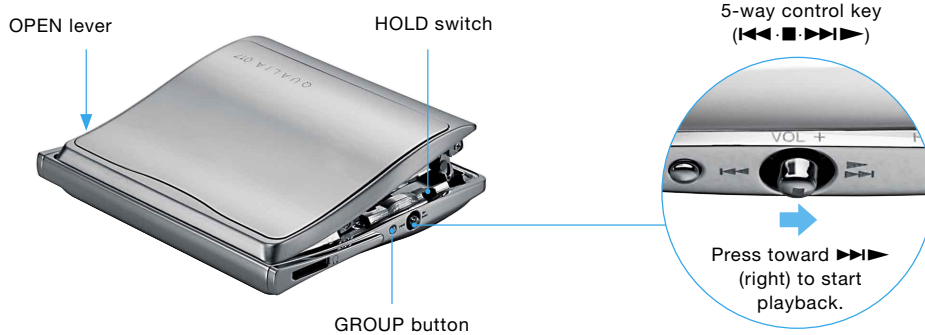
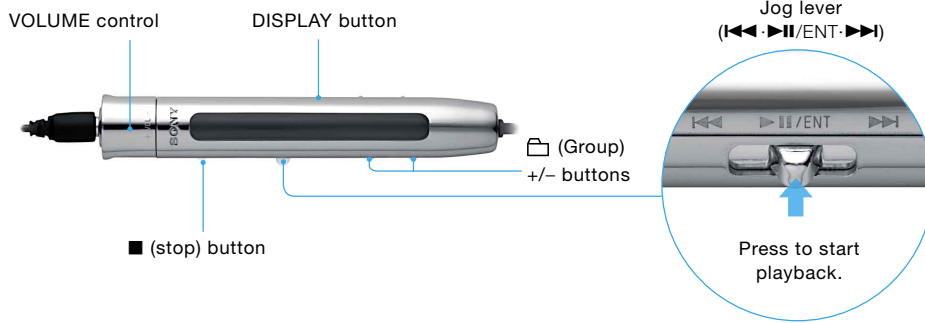

To open the lid

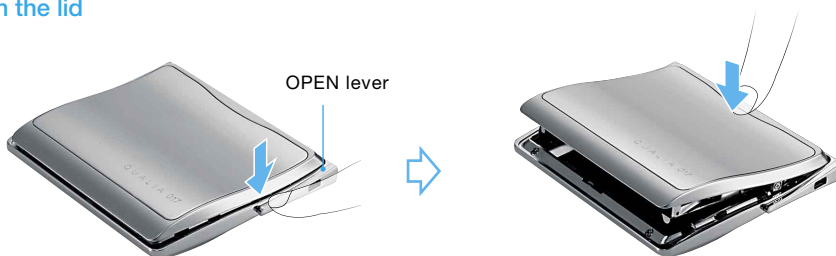



Place the player so that the side with the letters "QUALIA 017" faces up. Then push down the OPEN lever slightly to open the lid.



Push down the back of the lid as shown above to open it wider.

- 1 Open the lid (see page 18).
- 2 Insert an MD with the label side facing up, and push the MD in the direction of the arrow. Then close the lid.



- 3 Release the HOLD function if it is on (page 20).
- 4 To start playback, press the jog lever on the remote.
The operation lamp on the player lights up, and  (disc) on the remote display moves.
When you use controls on the player, press the 5-way control key towards  (right) to start playback.
- 5 To adjust the volume, turn the volume control towards VOL +/- on the remote.
The volume indicator appears on the remote display.
When you use controls on the player, press the 5-way control key toward + or - (up or down) to adjust the volume.

To stop playback

Press the  (stop) button on the remote. On the player, press the 5-way control key. Playback of the same MD starts from the point where you last stopped playing it. To start playback from the beginning of the same MD, press and hold the jog lever for two seconds or more. (On the player, press and hold the 5-way control key towards  for two seconds or more.) If you remove and reinsert the same MD after pressing the  (stop) button, playback will start from the beginning.

To pause playback

During playback, press the jog lever on the remote.  (disc) flashes on the remote display. To resume play after pausing, press the jog lever again.

Continued on the next page 

VOLUME control 5-way control key



Playing an MD (continued)

To check the MD information

Press the DISPLAY button repeatedly to check the MD information on the remote display. If the information, such as the track name, is longer than the display, the letters scroll from right to left.

When "Power Mode" is set to "Power Save" (page 31), the information is displayed only for several seconds by pressing the DISPLAY button.

MD information on the display

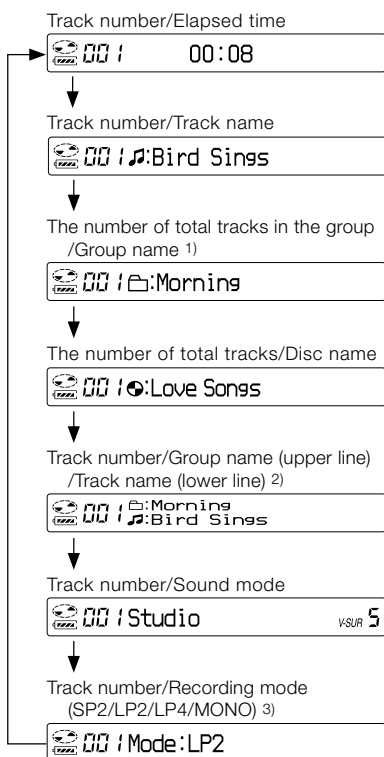

- 1) The display appears only for an MD with group settings.
- 2) The track name appears on the upper line for an MD with no group setting.
- 3) The display appears only during playback and changes automatically to the display of the track number and the elapsed time after a while.

Locking the controls – HOLD

In order to prevent accidental button presses while carrying the player, you can lock the controls (HOLD) for the remote and the player separately.

For example, you can operate the player by using the remote even if the HOLD function on the player is activated.

To lock the controls on the player

- 1 Open the lid following the steps in "To open the lid" (page 18).
- 2 Slide the HOLD switch, located inside on left side of the player toward ►. The controls on the player are disabled.

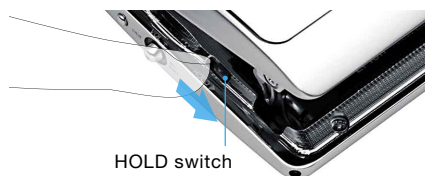

To unlock the controls, slide the HOLD switch in the opposite direction of ►.

To lock the controls on the remote

Slide the HOLD switch on the remote toward ◀, so that yellow shows on the right end. The controls on the remote are disabled.



To unlock the controls, slide the HOLD switch in the opposite direction of ◀.

Changing the playback operations

You can play back the track or position you want by going to the beginning of the track, going forward, or going backward.

To use the jog lever on the remote

Slide toward **⏮** (left) to go backward from the current point.



Slide toward **⏭** (right) to go forward from the current point.

To use the 5-way control key on the player

Press toward **⏮** (left) to go backward from the current point.



Press toward **⏭** (right) to go forward from the current point.

To	Do this
Go to the beginning of the current track or the previous track	Slide the jog lever toward ⏮ on the remote. On the player, press the 5-way control key toward ⏮ .
Go to the beginning of the next track	Slide the jog lever toward ⏭ on the remote. On the player, press the 5-way control key toward ⏭ .
Search for a specific position by fast forwarding or reversing while viewing the elapsed time (Time search)	During playback or pause, slide and hold the jog lever left or right. While checking the elapsed time on the remote display, you can go to the specific position you want to listen to.
Search for a specific track while viewing track numbers (Index search)	During stop, slide and hold the jog lever left or right. While checking the track number on the remote display, you can go to the specific track you want to listen to.
Go to the beginning of every 10th track*	Press the ⏮ (group) – button on the remote to go to the beginning of the 10th track before the current track. Press the ⏮ (group) + button on the remote to go to the beginning of the 10th track after the current track.
Go to the beginning of every group** (Group skip)	Press the ⏮ (group) – button on the remote to go to the beginning of the first track in the current group or the previous group. Press the ⏮ (group) + button on the remote to go to the beginning of the first track in the next group. On the player, press the GROUP button, and then press the 5-way control key left or right.

* You can do this only for an MD with no group settings.

**You can do this only for an MD that has group settings. For details on the group setting, see page 25.

Continued on the next page [→](#)

Playing an MD (continued)

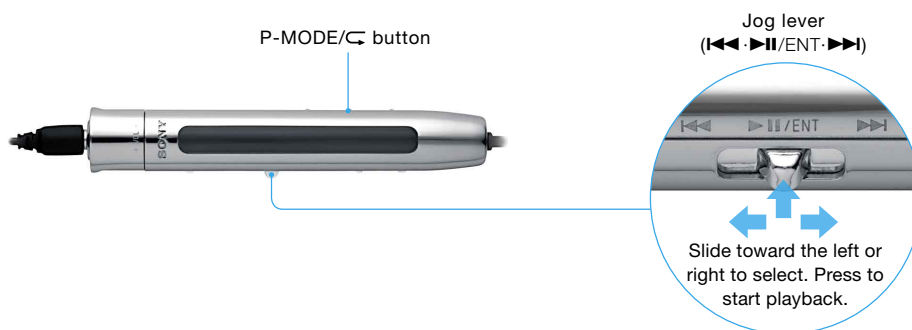

Changing the play mode – P-MODE/⏏

Besides playing the tracks in the order recorded on an MD (normal play), you can also select the specific tracks you want to listen to, and then play tracks in your favorite order.

For details about the play mode, see page 23.

- 1 While the player is stopped, press the P-MODE/⏏ button repeatedly until the play mode indication you want appears. To use  (bookmark track play), tracks first need to be bookmarked. Before pressing the P-MODE/⏏ button, be sure to bookmark the tracks you want (page 24).

When you select PGM (program play), the indication flashes. Continue setting the program from step 2 in “To listen to tracks in the desired order” (page 24).

- 2 Press the jog lever. Playback starts in the selected play mode.





To return to normal play, press the P-MODE/⏏ button repeatedly until the play mode indication disappears.

Also, press and hold the jog lever for two seconds or more while the player is stopped, or open and close the lid of the player* to return to normal play.

* Except for when the MD information has been stored in the “Disc Memory” (page 29).

You can also play tracks repeatedly in the selected play mode by using repeat play. For details, see page 24.

Play mode list

Play mode indication	Description
No display (Normal play)	All the tracks on the MD are played once in a track number order. Press and hold the jog lever for two seconds or more while the player is stopped or open and close the lid of the player* to return to normal play.
1 (Single-track play)	The current track is played once.
 (Bookmark track play)	The tracks you bookmarked are played. For details on how to add a bookmark, see page 24.
SHUF (Shuffle play)	All the tracks on the MD are played once in random order.
PGM (Program play)	The tracks are played in the order that you specified. For details on how to set the program, see page 24.
 ** (Group normal play)	All the tracks in all the groups are played once in a group order. Tracks not assigned to a group are played after the tracks assigned to groups.
 SHUF ** (In-group shuffle play)	All the tracks in the current group are played once in random order. After playing the current group, the tracks in the succeeding groups are played once in random order.
 PGM ** (Group program play)	The groups are played in the order that you specified. Up to 10 groups can be programmed.





* Except for when the MD information has been stored in the "Disc Memory" (page 29).

**The indicator appears only during playback of an MD with group settings. For details about group setting, see page 25.

Continued on the next page →

Playing an MD (continued)

To listen to selected tracks only – Bookmark track play

- 1 To add a bookmark, play back the track that you want to bookmark. Then, press and hold the jog lever for two seconds or more until  (bookmark track play) flashes slowly, during playback of the track which you want to bookmark.
- 2 To bookmark another track, repeat step 1. You can bookmark up to 20 tracks.
- 3 To listen to the bookmarked tracks, press the P-MODE/ button repeatedly until  (bookmark track play) flashes. “ TrPLAY?” appears.
- 4 Press the jog lever.  lights up and the bookmarked track starts playback. When you bookmark two or more tracks, the playback is in a track number order.

To erase a bookmark, play the bookmarked track and then press and hold the jog lever for two seconds or more.

To erase all bookmarks, open and close the lid of the player.



To listen to tracks in the desired order – Program play



- 1 To program the desired order, press the P-MODE/ button repeatedly until “PGM” (program play) flashes.
- 2 Slide the jog lever left or right to select a track, and then press the jog lever to enter the selected track.
- 3 Repeat step 2 to program more tracks in the order you want to play. You can program up to 20 tracks. All program settings are cancelled when the lid is opened.
- 4 To listen to the tracks in the programmed order, press and hold the jog lever for two seconds or more until “PGM” stops flashing. Playback starts in the selected order.

To start the program play again after changing the play mode, follow step 1 to make “PGM” (program play) flash. Press and hold the jog lever for two seconds or more to start playback.

To erase the programs, open and close the lid.

To play tracks repeatedly – Repeat play

- 1 Select the play mode you want to repeat (page 23).
- 2 Press and hold the P-MODE/ button for two seconds or more until  (repeat play) appears. The selected play mode repeats.

To cancel repeat play, press and hold the P-MODE/ button for two seconds or more until  (repeat play) disappears. To change the play mode, press the P-MODE/ button during repeat play.

To listen to tracks using the group function

Although you cannot use this player to set groups, you can play an MD that already has group settings.

To listen to tracks using the group function, press the P-MODE/◀ button repeatedly until ◻, ◻SHUF, or ◻PGM lights up. For details about each play mode, see page 23. In the ◻ (group normal play), tracks not assigned to a group are played after the tracks assigned to groups. In the example “MD with group settings,” tracks 6 and 7 are played after the tracks in Groups 1 to 3. During playback of tracks 6 and 7, “Group --” appears in the display. In the ◻SHUF (in-group shuffle play) and ◻PGM (group program play), tracks not assigned to a group are not played.

About group settings

The tracks on an MD are numbered in the recorded order.

MD with no group settings

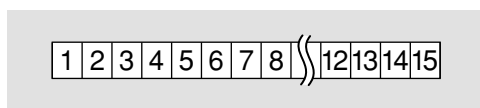

If you use the MD recorder that can set the groups, you can assign desired tracks to a group as shown in the example “MD with group settings.” For details on how to set the groups, see the operating instructions of the MD recorder.

MD with group settings

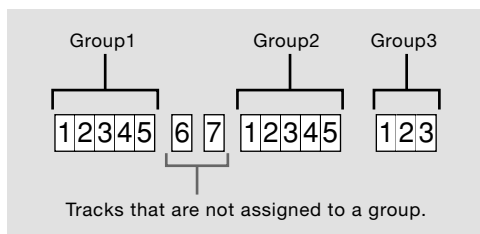

Operation lamp for the group settings

Using the color of the operation lamp on the player, you can check during play whether the MD has the group settings.

Operation lamp	Group setting status of the MD
Red	Playing an MD with no group settings
Green	Playing an MD with group settings
Orange	Going to the beginning of another group (page 21)

Selecting the sound mode – V-SUR/SOUND

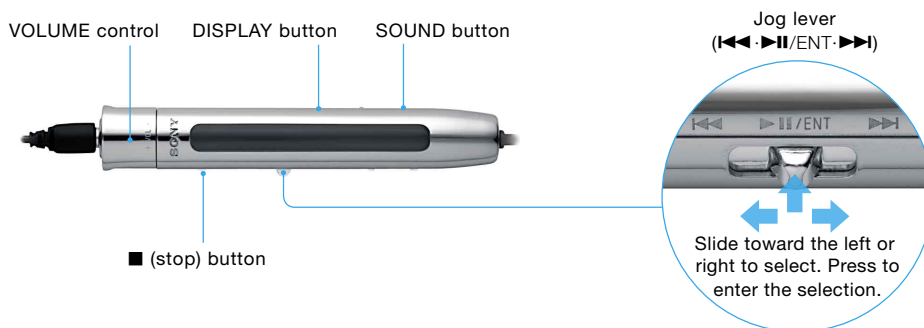

You can select the sound mode you want from the modes available on the player. In “V-SUR” (Virtual Surround), there are four sound pre-settings that let you hear the sound as if you are in a recording studio, at a concert, etc. In “SOUND,” there are six sound pre-settings (6 Band Equalizer). Four pre-settings provide a specific audio range according to the sound genre, such as jazz and pops. Two custom settings, “Custom1” and “Custom2,” let you set each of the six sound ranges in up to seven increments to give you more flexibility to achieve the desired sound.

- 1 During playback, press the SOUND button repeatedly until “V-SUR” or “SOUND” appears.
- 2 Press and hold the SOUND button for two seconds or more until the selected indicator flashes.
- 3 Slide the jog lever left or right to select the sound mode, and then press the jog lever. The selected sound mode is set. When you select “Custom1” or “Custom2,” follow the steps in “To customize the sound – Custom” on page 27.

To cancel the setting, press the SOUND button repeatedly until “V-SUR” or “SOUND” disappears.

To cancel the procedure, press and hold the DISPLAY button or the ■ (stop) button for two seconds or more.

Sound mode settings

Mode (<u>underlined:</u> default setting)	Explanation
V-SUR <u>Studio</u>	Recreates the sound of a recording studio
Live	Recreates the sound of a concert hall
Club	Recreates the sound of a dance hall
Arena	Recreates the sound of a stadium
SOUND <u>Heavy</u>	Dignified sound
Pops	Light and soft sound
Jazz	Emphasis on the bass tone
Unique	Emphasis on both the high and bass tones
Custom1	Up to two kinds of desired sound can be stored
Custom2	

To customize the sound – Custom

You can store two sound settings that are finely adjusted in all six sound ranges.

- 1 Select “Custom1” or “Custom2” in step 3 of “Selecting the sound mode – V-SUR/SOUND” on page 26, and press the jog lever. One “-”, which shows the sound level, flashes.



- 2 Slide the jog lever left or right to make the range you want to adjust flash. The six “-”s show the sound range of 100Hz, 250Hz, 630Hz, 1.6kHz, 4kHz, or 10kHz from the left.



- 3 Turn the volume control toward +/- to adjust the sound volume of the selected range in a maximum of seven increments. The center is 0dB. Each turn toward – increases the volume to +3dB, +6dB, and +10dB in order, and each turn toward + moves it to –3dB, –6dB, and –10dB in order.



- 4 Repeat steps 2 and 3 to adjust the volume for each range.
- 5 After adjusting, press the jog lever. The sound setting you selected is stored as “Custom1” or “Custom2.” Once you have stored the sound setting, it will remain until a new one is stored.

Changing the settings

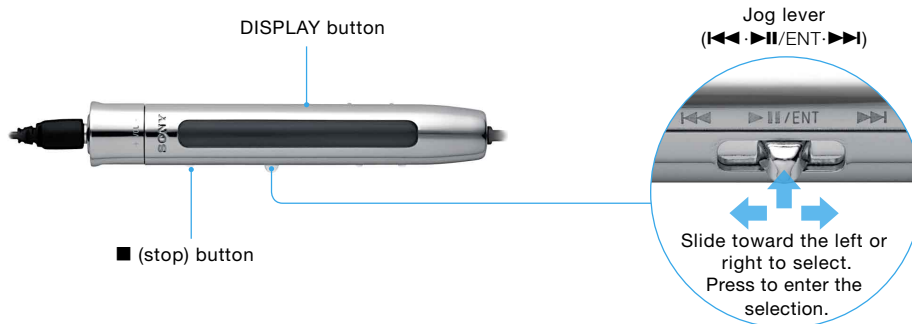

- 1 Press and hold the DISPLAY button for two seconds or more until “Useful” or “Option” flashes.



- 2 Slide the jog lever left or right to select “Useful” or “Option,” and then press the jog lever. For details about the items in “Useful” and “Option,” see “Menu option” (pages 29 to 31).



- 3 To continue to select items you want to change, slide the jog lever again left or right and press the jog lever.



After setting, return to the original display. To return to the previous display, press the ■ (stop) button. To cancel setting, press and hold the DISPLAY button or the ■ (stop) button for two seconds or more.

Menu option

“Useful” menu

Use the “Useful” menu to change an MD’s setup options.

Item	Options (<u>underlined</u> : default setting)
Disc Memory	<p>The player can store the various settings of an MD (volume, play mode, bookmark, sound mode, speedcontrol, etc.), and then retrieve them automatically whenever the disc is inserted (Personal Disc Memory). Settings can be stored for up to 20 MDs. Any settings stored thereafter will replace the settings for the MD with the oldest playback data.</p> <p><u>ENTRY</u> Select “ENTRY?”, and then press the jog lever. “ENTRY OK” appears and then the settings are stored. If you add tracks or edit an MD whose settings have been stored on the player, the MD will no longer be recognizable by the player and the stored information is lost.</p> <p>ERASE Select “ERASE?”, and then press the jog lever. “ERASE OK” appears and the settings are erased. If you try to erase the settings of an MD that has not been stored, “NO ENTRY!” appears.</p>
SpeedControl	<p>This setting changes the playback speed without changing the playback pitch (Digital Pitch Control). You can use this function for studying languages, or for listening to recorded speeches.</p> <p>+100% During playback, slide the jog lever left or right to select the playing speed. Then press the jog lever. } The playback speed varies in 13 steps. The speed gets faster as the “+” number increases and slows down as the <u>0%</u> “-” number increases. } -50%</p> <div style="border: 1px solid black; padding: 5px; width: fit-content; margin: 10px auto;"> 00 1SC<+ 5%></div> <p>To cancel “SpeedControl,” open and close the lid of the player or select the normal speed (0%).</p>

Note

- When using “SpeedControl,” you may hear noise or an echo in the playback. This is not a malfunction.

Continued on the next page >>>

Menu option (continued)

“Option” menu

Use the “Option” menu to change the player’s setup options.

Item	Options (<u>underlined</u> : default setting)
AVLS	<p>This setting limits the maximum volume to prevent leakage of sound and damage to your hearing (Auto Volume Limiter System).</p> <p><u>AVLS Off</u> The volume changes as the VOLUME control is turned.</p> <p>AVLS On The Auto Volume Limiter System is on. If the fixed volume is exceeded, “AVLS” flashes and the volume remains at a moderate level.</p>
Beep	<p>This setting lets you turn on or off the beep that is emitted when the player or the remote is operated.</p> <p><u>Beep On</u> The beep sounds.</p> <p>Beep Off The beep does not sound.</p>
Backlight	<p>This setting lets you turn the remote display backlight on or off.</p> <p><u>Auto</u> The backlight turns on when you operate the remote, and automatically turns off when the player is not used for a while.</p> <p>On The backlight stays on.</p> <p>Off The backlight stays off.</p>
表示方式選択	<p>This setting selects a title display on the remote, when you insert an MD with a Japanese title.</p> <p><u>漢字優先</u> Only the Japanese title in Japanese mode is displayed.</p> <p>漢字カナ交互 The titles in Japanese mode and English mode are displayed alternately.</p>

Item	Options (<u>underlined</u> : default setting)
Power Mode	This setting determines battery use.
	<p><u>Normal</u> During playback, the operation lamp on the player and the remote display always light up.</p>
	<p>Power Save During playback, the operation lamp on the player and the remote display remain turned off. This leads to a longer battery life. The remote display lights up for only several seconds when the DISPLAY button is pressed.</p>
<p>Quick Quick response for the playback operation is given priority over the battery life. When operating to start playback or go to the beginning of a track, playback will start quickly. Also during playback, the operation lamp on the player and the remote display remain lit. Because the battery is always used even when the player is not operating, this leads to a shorter battery life. For this reason, it is recommended that you charge the battery frequently if you plan to use the “Quick” option.</p>	

Note

- If no player operation (including opening or closing of the lid) occurs for about 17 hours when “Power Mode” function is set to “Quick” mode, the response when the player is next used may be slow. The player, however, will return to “Quick” response after it has been used again.

Caring for the player

For the player and the remote

To remove any fingerprints or dirt, it is recommended that you wipe the player and remote with the supplied cleaning cloth. The cleaning cloth can be washed and reused when it becomes dirty.

For the earbuds

To clean the earbuds, remove them from the headphones, and then wash them by hand with a weak solution of neutral detergent. Wipe the earbuds thoroughly to remove any moisture before using them.

For the supplied carrying case

Wipe the surface with the dry, supplied cleaning cloth.

When the player is not used for three months or more

To prevent the battery from running down, set the BUILT-IN BATTERY switch to OFF to disconnect the power supply to the player.

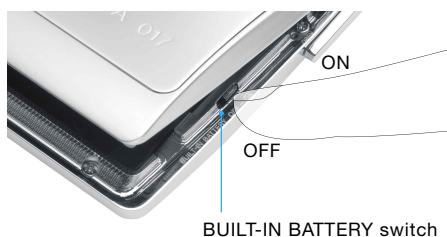

Precautions

On safety

- Make sure to keep the player in the supplied carrying case. If the terminals on the player or the battery charging stand are accidentally brought into contact with a metallic object, they may short-circuit and begin to heat up.
- Keep the terminals on the player away from metallic objects or surfaces. Such contact may short-circuit the terminals and cause dangerous heat generation.
- Do not put any foreign objects in the DC IN 6V jack.
- If you will not use the player for a long time, be sure to disconnect the power supply (AC power adaptor or the battery charging stand). When disconnecting the AC power adaptor from the electrical outlet, grasp the adaptor plug itself; never pull the cord.

On the AC power adaptor (for the supplied battery charging stand)

- For use in your house: Use the supplied AC power adaptor. Do not use any other AC power adaptor; it may cause the player to malfunction.

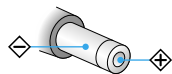

Polarity of the plug

- Connect the AC power adaptor correctly.
- Do not touch the AC power adaptor with wet hands.
- Connect the AC power adaptor to an easily accessible AC outlet. Should you notice an abnormality in the AC power adaptor, disconnect it from the AC outlet immediately.

On charging

- The supplied battery charging stand can be used only with the QUALIA 017. It cannot be used to charge any other models.
- Charge the built-in battery at a temperature of 0°C (+32°F) to +40°C (+104°F). The charging time will vary according to the room temperature. (If the room temperature is low, the required charging time will be longer. This is a characteristic of the built-in lithium-ion battery.)
- Because of the battery's characteristics, the capacity of the built-in rechargeable battery may be smaller than normal when it is used for the first time or after a long period of disuse. In this case, charge and discharge the battery several times. The normal battery life will be restored.
- If the life of the built-in rechargeable battery drops to half the normal length, the battery should be replaced. Contact QUALIA Concierge.
- If the player will not be used for a long time, remove the player from the battery charging stand and disconnect the AC power adaptor from the wall outlet. If the player will not be used for three months or more, we also recommend that you set the BUILT-IN BATTERY switch (for built-in rechargeable battery) located inside right side of the player to OFF.

Continued on the next page →

Precautions (continued)

On handling

- Do not drop or bump the player. This may cause the player to malfunction.
- Do not pull on the remote or headphone cords.
- Do not leave the player in the following places:
 - An extremely hot place (over 60°C (140°F))
 - A place exposed to direct sunlight or near a heater
 - In a car with the windows rolled up (especially in the summer)
 - In a damp place such as a bathroom
 - Near a source of electromagnetic fields such as a magnet, speaker, or TV
 - In a dusty place

On heat build-up

Heat may build up in the player when it is charging or operated for a long time. This is normal.

On mechanical noise

The player emits mechanical noise while operating, which is caused by the power-saving system of the player. This is normal.

On installation

- Never use the player where it will be subjected to extremes of light, temperature, moisture or vibration.
- Never wrap the player in anything when it is being used with the AC power adaptor. Heat built-up in the player may cause malfunction or injury.

On disposing of the player

Before you dispose of the player, remove the built-in rechargeable battery for environmental protection.

To remove the built-in battery

Follow the steps on page 35 to remove the built-in rechargeable battery. When removing the battery, use a screwdriver.

Notes

- Before removing the built-in rechargeable battery, make sure it is completely drained.
- Do not remove any screw from the player except when disposing of the player.

- 1 Place the player on a flat place with the embossed "QUALIA 017" facing up, and then push down the OPEN lever slightly to open the player lid.

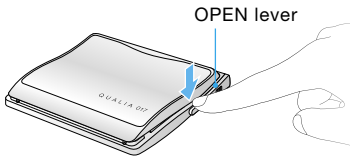

- 2 Push down on the part of the arrow shown below to open the lid wider.

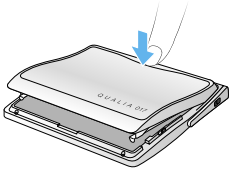

- 3 Set the BUILT-IN BATTERY switch located inside the right side of the player in the direction of the arrow.

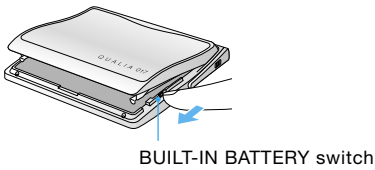

- 4 Remove the two screws from the player as shown below.

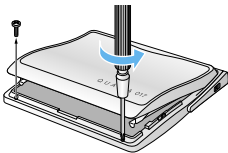

- 5 Turn the player over with the embossed "SONY" facing up. Then move the bottom in the direction of the arrow to remove it.

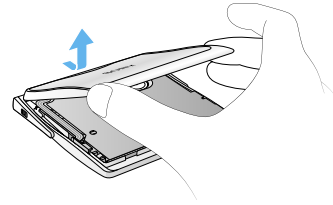

- 6 Remove the black insulating sheet.

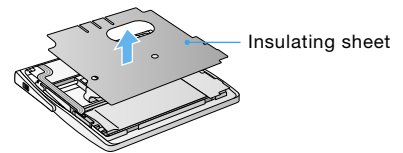

- 7 Remove the built-in rechargeable battery in the battery holder.

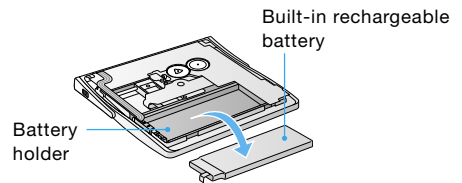

- 8 Attach a piece of insulating tape over the power supply board connector.

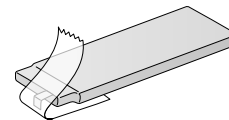

Continued on the next page >>>

On the remote

The supplied remote is designed for use with the QUALIA 017 only. Note also that the player cannot be controlled by a remote for other models.

On the MD cartridge

- Do not touch the internal disc directly. Forcing the shutter open may damage the internal disc.
- When transporting an MD, keep it in its case.
- Do not place the cartridge where it will be subjected to light, temperature, moisture or dust.
- Do not affix the label outside of the specified area on the MD. Make sure the label is placed within the recessed space on the disc.

On the headphones

Road safety

- Do not use headphones while driving, cycling, or operating any motorized vehicle. This may lead to a traffic accident and is illegal in many areas. It can also be potentially dangerous to play your player at high volumes while walking, especially at pedestrian crossings. You should exercise extreme caution or discontinue using the player in potentially hazardous situations.
- Although headphones with a stereo mini plug can be connected, headphones with a micro plug cannot be used.
- Some of noise-canceling headphones that reduce the surrounding noise may not be able to be connected.
(For Sony models: MDR-NC20, MDR-NC11, and MDR-NC5)
- If you experience an allergic reaction to the supplied headphones, stop using them at once and contact QUALIA Concierge.

Preventing hearing damage

Avoid using headphones at high volumes. Hearing experts advise against continuous, loud and extended play. If you experience a ringing in your ears, reduce the volume or discontinue use.

Consideration for others

Keep the volume at a moderate level. This will allow you to hear outside sounds and to be considerate of the people around you.

On cleaning

- After wiping the player casing with a soft cloth slightly moistened with water, wipe it again with a dry cloth. Do not use any type of abrasive pad, scouring powder or solvent such as alcohol or benzene as this may mar the finish on the casing.
- Wipe the disc cartridge with a dry cloth to remove dirt.
- Dust on the lens may prevent the unit from operating properly. Be sure to close the disc compartment lid after inserting or ejecting an MD.
- To maintain good sound quality, use a soft cloth to clean the plugs of the headphones and remote. A dirty plug may cause noise or intermittent breaks in the sound during playback.

On the carrying case

- Avoid leaving the carrying case in a hot and humid place, because heat and moisture may cause changes in its color and shape.
- Avoid leaving the carrying case against other leather products or vinyl material for a long time, because that may cause changes in its color and quality.

If you have any questions or problems concerning your player, please contact QUALIA Concierge.

(If a problem occurred when the disc was in the player, we recommend that the disc be left in the player when you contact QUALIA Concierge so that the cause of problem may be better understood.)

Troubleshooting

If you experience a problem with your player, try the following solutions.

- 1 Read through the symptoms and solutions on pages 38 to 40 to check your player.
- 2 Detach the remote and the headphones from the player, and then reattach them and operate the player.
- 3 Set the BUILT-IN BATTERY switch to OFF and let the player sit for about 30 seconds. Then set the BUILT-IN BATTERY switch to ON again and operate the player.
- 4 Unplug the AC power adaptor from the battery charging stand and the wall outlet. Then plug them in again and operate the player.
- 5 If the problem persists, contact QUALIA Concierge.

QUALIA Concierge
Toll-free number:
1 (877) QUALIA3

Symptom	Cause/Solution
The built-in rechargeable battery does not charge.	<ul style="list-style-type: none">•The battery is charged when shipped. Check the remaining power of the built-in rechargeable battery (page 16).•When “CannotCHG” appears, the room temperature is too high or too low. Charge the battery at a temperature of 0°C (+32°F) to +40°C (+104°F).•When recharging is started after using up the built-in rechargeable battery, it may take up to one minute for the operation lamp on the player or display indication on the remote to go on.•Firmly insert the plug of the AC power adaptor into the jack at the bottom of the battery charging stand.
The operation lamp on the player does not light up even when the player is placed on the battery charging stand.	<ul style="list-style-type: none">•Open the lid of the player and set the BUILT-IN BATTERY switch located inside the right side of the player to ON.

Symptom	Cause/Solution
The player does not work or works poorly.	<ul style="list-style-type: none"> • Open the lid of the player, and then set the BUILT-IN BATTERY switch located inside the right side of the player to ON. • Make sure that the HOLD function of the player or the remote is set off (page 20). • Insert an MD if “NO DISC” is displayed. • End the setting operation using the remote if “MENU” is displayed. • Recharge the built-in battery if “LOW BATT” is displayed (page 14). • Insert a recorded MD if “BLANKDISC” is displayed. • Reinsert the MD if “READ ERR” or “TOC ERR” is displayed. If the error message continues to be displayed, replace the MD with another one. • When moisture condenses inside the player, remove the MD from the player, set the BUILT-IN BATTERY switch to OFF, and leave the player for several hours. <p>If you cannot solve the problems with the methods above, or if the problems occurred due to the following causes, follow the steps below.</p> <ul style="list-style-type: none"> — While operating, the player received a mechanical shock. — The player was affected by strong noise caused by too much static, an abnormal power surge due to lightning, etc. <ol style="list-style-type: none"> 1 Set the BUILT-IN BATTERY switch to OFF. 2 Let the player sit for about 30 seconds. 3 Set the BUILT-IN BATTERY switch to ON and reconnect the player to a power source.
There is no sound output from the headphones.	<ul style="list-style-type: none"> • Firmly plug the remote into the player and the headphones into the remote.
The volume does not increase.	<ul style="list-style-type: none"> • Set “AVLS” to “Off” (page 30).

Continued on the next page >>>

Troubleshooting (continued)

Symptom	Cause/Solution
The MD does not play normally.	<ul style="list-style-type: none"> • Stop playback when another play mode is selected. Then press and hold the jog lever for two seconds or more. • When the repeat play is selected, press and hold the P-MODE/⏮ button for two seconds or more until ⏮ disappears.
The MD does not play from the first track.	<ul style="list-style-type: none"> • Playback with same MD starts from the point you last stopped playing. To start playback from the beginning of the same MD, press and hold the jog lever on the remote for two seconds or more (or press and hold the 5-way control key on the player toward ►►► for two seconds or more). Or you can press ■ (stop) button and reinsert the MD. Playback will start from the beginning because the player will consider the MD to be a different one.
The playback sound skips.	<ul style="list-style-type: none"> • When you use the player in a location that has a lot of vibration, place the player where the vibration is the least. • A very short track, such as a brief narration or introduction, may cause sound to skip. • Do not continuously give strong shocks to the player. • Do not use a dirty or scratched MD.
Noise is heard.	<ul style="list-style-type: none"> • Move the player away from a television or other source of strong magnetism which is causing interference.
Noise is briefly heard.	<ul style="list-style-type: none"> • Because of the nature of the compression method used in the LP4 mode, noise may be output on very rare occasions during playback of sound recorded in this mode. • Noise may be output when the cord of the headphones touches the clothing, etc. This is not a malfunction.
During playback, the operation lamp of the player or the remote display does not light up.	<ul style="list-style-type: none"> • When "Power Mode" is set to "Power Save," the lamp and display do not light up except during operation. Select "Quick" or "Normal" (page 31).
The group settings do not function.	<ul style="list-style-type: none"> • Insert an MD with group settings (page 25).

Specifications

Type of material	Copper pyrites (brass), palladium-plated finish (not including switches/remote display)	Frequency response	20 to 20,000 Hz ± 3 dB
Process method	Shaped with NC (Numerically Control) Machine Tool (not including the remote display)	Outputs	Headphones: dedicated headphone/remote jack, maximum output level 5 mW + 5 mW load impedance 16 Ω
Audio playing system	MiniDisc digital audio system	Power requirements	Lithium-ion rechargeable battery (Built-in: LIP-3WMB, 3.7 V, 340 mAh, Li-ion) External power jack (for the battery charging stand): Power rating 6 V DC AC power adaptor (for the battery charging stand, supplied), AC 120 V, 60 Hz
Laser diode properties	Material: GaAlAs Wavelength λ=790 nm Emission duration: continuous Laser output: less than 44.6 μW* *This output is the value measured at a distance of 200 mm from the objective lens surface on the optical pick-up block with 7mm aperture.	Battery operation time	See "Checking the battery's remaining power" (page 16)
Revolutions	Approx. 300 rpm to 2,700 rpm	Dimensions	Approx. 87.6 × 79.0 × 11.0 mm (w/h/d) (3 ¹ / ₂ × 3 ¹ / ₈ × 7 ¹ / ₁₆ inches) (not including projecting parts and controls)
Error correction	ACIRC (Advanced Cross Interleave Reed Solomon Code)	Mass	Approx. 244 g (8.7oz) (including the built-in rechargeable battery)
Sampling frequency	44.1 kHz	US and foreign patents licensed from Dolby Laboratories.	
Coding	ATRAC (Adaptive Transform Acoustic Coding) ATRAC3: LP2/LP4	Design and specifications are subject to change without notice.	
Modulation system	EFM (Eight to Fourteen Modulation)		
Number of channels	2 stereo channels 1 monaural channel		



Printed on 100% recycled paper using VOC (Volatile Organic Compound)-free vegetable oil based ink.

A

AC power adaptor 14
AVLS..... 30

B

Backlight 30
Battery charging stand 14
Battery life..... 16
Beep 30
Bookmark track play 24
BUILT-IN
 BATTERY switch 10, 32
Built-in rechargeable battery ... 15

C

Caring for the player 32
Changing the settings 28
Charging the battery 14
 Charging progress chart .. 15
Custom 27

D

DC IN 6V plug..... 14
Disk Memory 29
DISPLAY button..... 11, 20
Display of
 the remaining power 16

G

Go backward/forward..... 21
Go to the beginning of track ... 21
GROUP button 10, 21
Group function..... 25
Group normal play 23
Group program play 23
Group skip 21

H

HOLD..... 20
HOLD switch 10, 11, 20

I

In-group shuffle play 23
Index search..... 21

J

Jog lever
(/ENT.) 11, 18

M

MD information
 on the display 20

N

Normal 31
Normal play 23

O

“Option” menu 30
OPEN lever..... 10, 18
Operation lamp 10, 14

P

P-MODE/ (repeat)
 button 11, 22
Pause playback 19
PGM (Program play) 23
Playing an MD 18
 Changing
 the playback operations.. 21
 Changing the play mode .. 22
 Play mode..... 12, 23
Power from a wall outlet 15
Power Mode 31
Power Save 31
Precautions 33
Program play 24

Q

Quick 31

R

Remote display 12, 14, 20
Repeat play 24

S

SHUF (Shuffle play)	23
Shuffle play	23
Single-track play	23
SOUND	26
SOUND button	11, 26
Sound mode.....	12, 26
SpeedControl	29
Stopping playback	19
Supplied accessories	13

T

Terminals for the battery charging stand	10, 14
Time search.....	21
Troubleshooting	38

U

"Useful" menu.....	29
--------------------	----

V

V-SUR.....	26
Virtual Surround.....	26
VOLUME control	11, 19

Symbol/Number

 (battery)	16
 (bookmark track play).....	24
 (disc).....	19
 (Group) +/- buttons	11, 21
 (Group normal play)	23
 (headphones) jack	10, 14
 (stop) button.....	11, 19
 (repeat play)	24
5-way control key 	10, 18
6 Band Equalizer.....	26